



2024 and 2028 Draft LCR Study Results Greater Fresno Area

Rondla Preethi

Senior Regional Transmission Engineer

Stakeholder Call

March 9, 2024

Greater Fresno Area

Electrical Boundaries and LCR Sub-Areas

Electrical Boundaries:

- Gates – Mustang #1 230 kV line
- Gates – Mustang #2 230 kV line
- Panoche – Tranquility #1 230 kV line
- Panoche – Tranquility #2 230 kV line
- Warnerville – Wilson 230 kV line
- Melones – Wilson 230 kV line
- Panoche 230/115 kV transformer #1
- Panoche 230/115 kV transformer #2
- Smyrna – Alpaugh – Corcoran 115 kV line
- Los Banos #3 230/70 kV transformer
- Los Banos #4 230/70 kV transformer
- San Miguel – Coalinga #1 70 kV line
- Gates 230/70 kV transformer #5

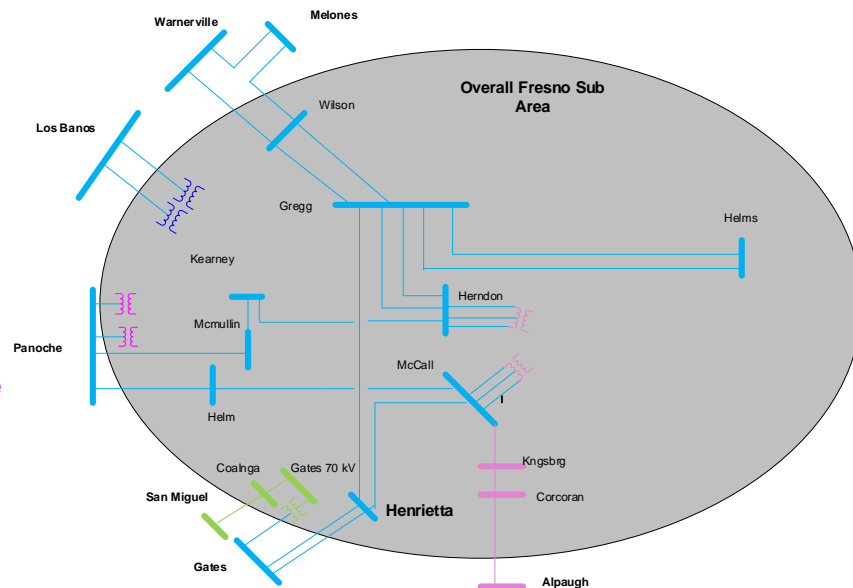

New major transmission projects

Project Name	Expected ISD
Northern Fresno 115 kV Area Reinforcement (Northern Fresno Reliability)	Completed
Wilson Voltage Support (Wilson 115 kV STATCOM)	Completed
Wilson-Legrand 115 kV Reconductoring	Completed
Kingsburg-Lemoore 70 kV Line Reconductoring	Completed
Herndon - Bullard 115 kV Reconductoring	Apr-24
Panoche-Oro Loma 115 kV Reconductoring	Mar-23
Wilson 115 kV Area Reinforcement	Mar-25
Oro Loma 70 kV Area Reinforcement	Jan-26
Giffen Line Reconductoring	Jan-23
Borden 230/70 kV Transformer Bank #1 Capacity Increase	Jan-27
Wilson-Oro Loma 115 kV Line Reconductoring	Dec-26
Bellota-Warnerville 230kV Reconductoring	Dec-24
Herndon - Bullard Nos. 1 and 2 115 kV Reconductoring	Dec-26
Reedley 70 kV Reinforcement (Renamed to Reedley 70 kV Area Reinforcement Projects Include Battery at Dinuba)	Dec-23

Power plant changes

Resource Additions:

- None

Resource Retirements:

- None

Hanford Sub-area: Load and Resources

Load (MW)	2024	2028	Generation (MW)	2024	2028
Gross Load	213	222	Market/Net Seller	133	133
AAEE	-1	-2	Battery	0	0
Behind the meter DG	-9	0	Muni/QF	0	0
Net Load	203	219	Solar	28	28
Transmission Losses	5	5	Existing 20-minute Demand Response	0	0
Pumps	0	0	Mothballed	0	0
Load + Losses + Pumps	208	224	Total Qualifying Capacity	161	161

Hanford Sub-Area Requirements

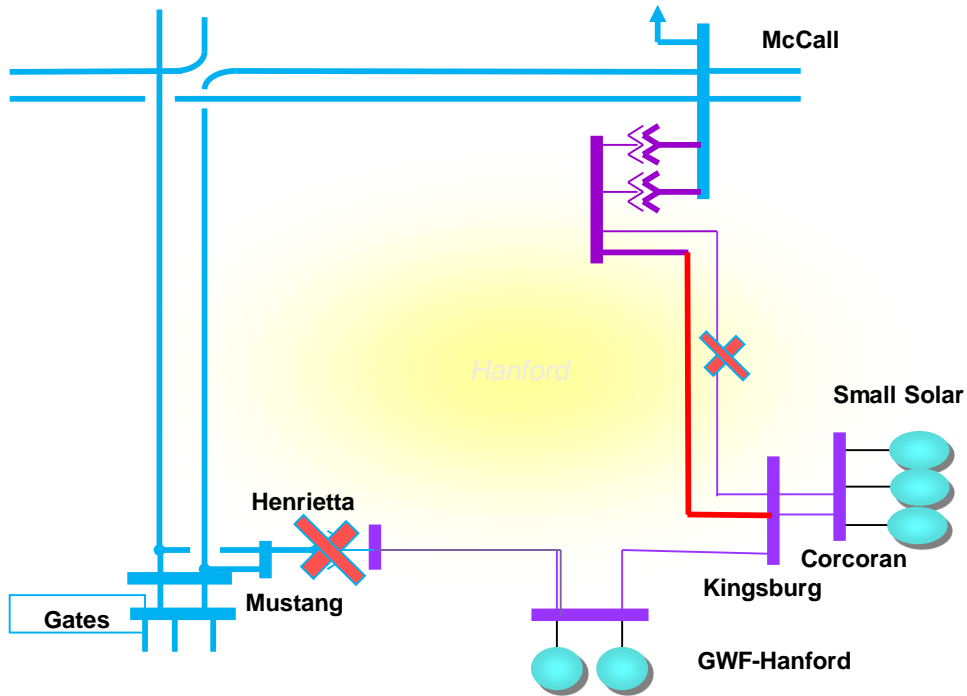

Limit	Category	Limiting Facility	Contingency	2024 LCR (MW)	2028 LCR (MW)
First Limit	P6	GWF-Contadina 115kV Line	McCall-Kingsburg #1 115kV line and McCall-Kingsburg #2 115kV line	58	62

Hanford Sub-area: Load Profiles

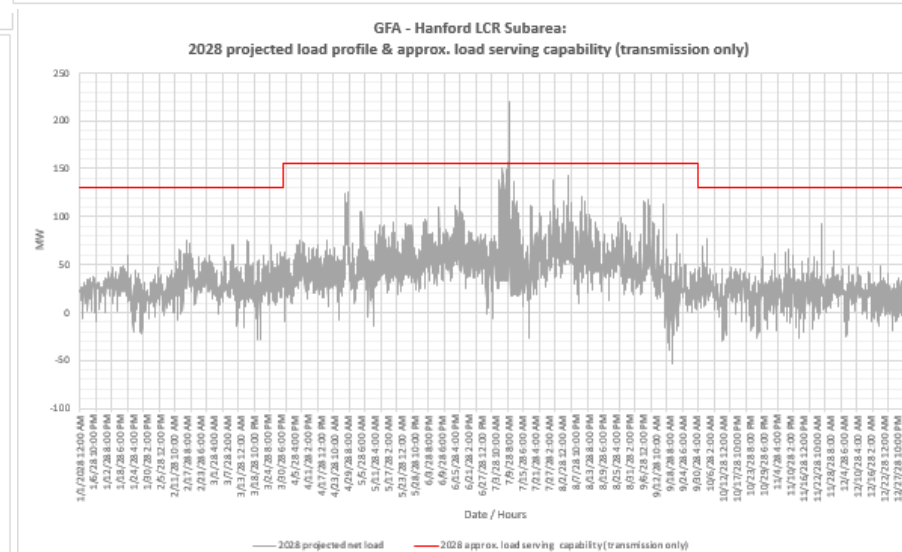
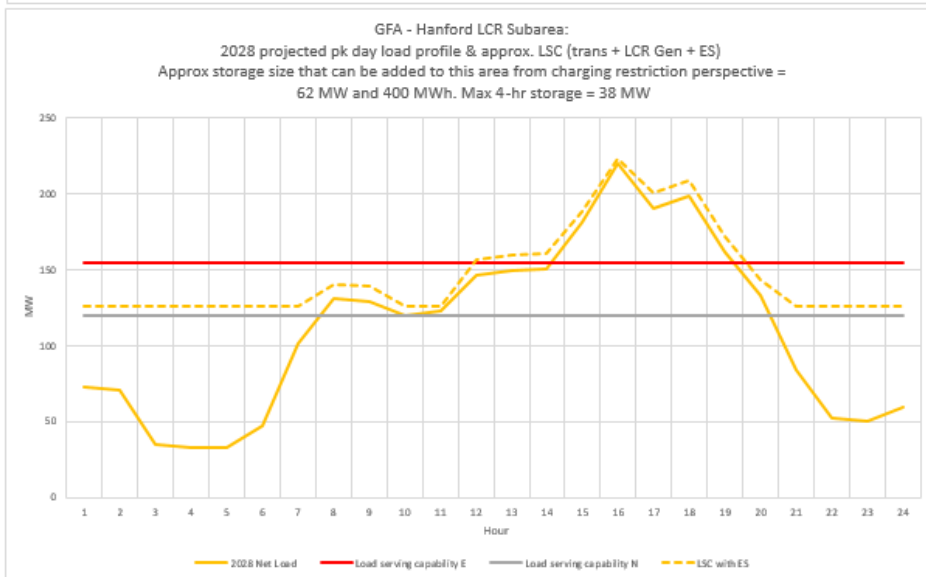
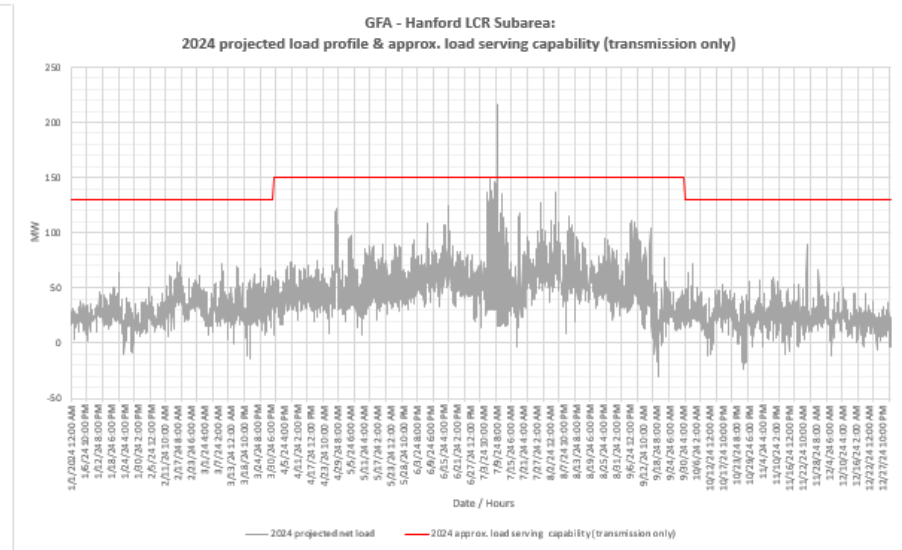
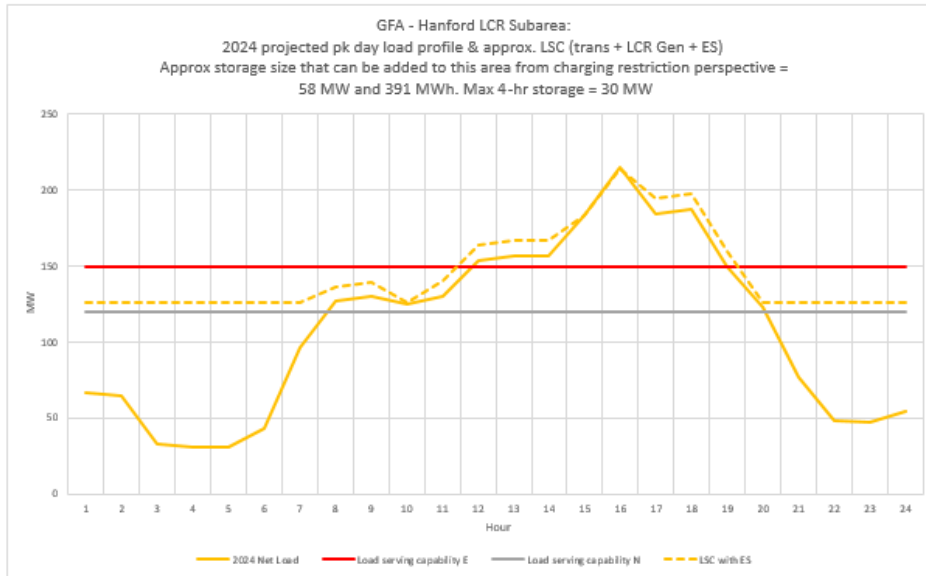

Coalinga Sub-area: Load and Resources

Load (MW)	2024	2028	Generation (MW)	2024	2028
Gross Load	151	155	Market, Net Seller	0	0
AAEE	-1	-1	Battery	0	0
Behind the meter DG	-3	0	Muni/QF	3	3
Net Load	147	154	Solar	12	12
Transmission Losses	3	2	Existing 20-minute Demand Response	0	0
Pumps	0	0	Mothballed	0	0
Load + Losses + Pumps	150	156	Total Qualifying Capacity	15	15

Coalinga Sub-Area Requirements

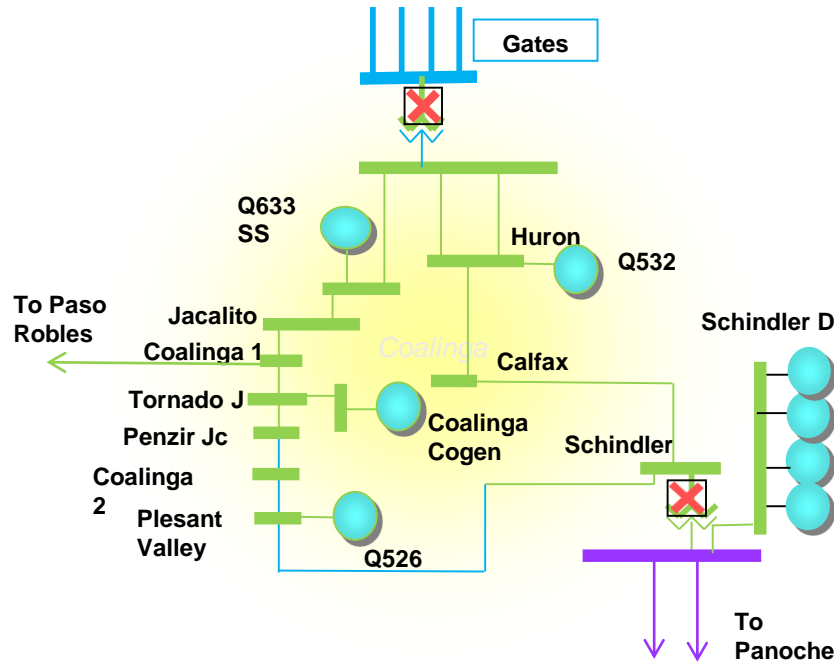

Limit	Category	Limiting Facility	Contingency	2024 LCR (MW)	2028 LCR (MW)
First Limit	P1	Overload on Fivepoint Solar-Calfax 70kV Line and Voltage Instability	T-1/T-1: Gates 230/70kV TB #5 and Schindler 115/70 kV TB#1	110 (95 NQC) (107 Peak)	116 (101 NQC) (113 Peak)

Coalinga Sub-area: Load Profiles

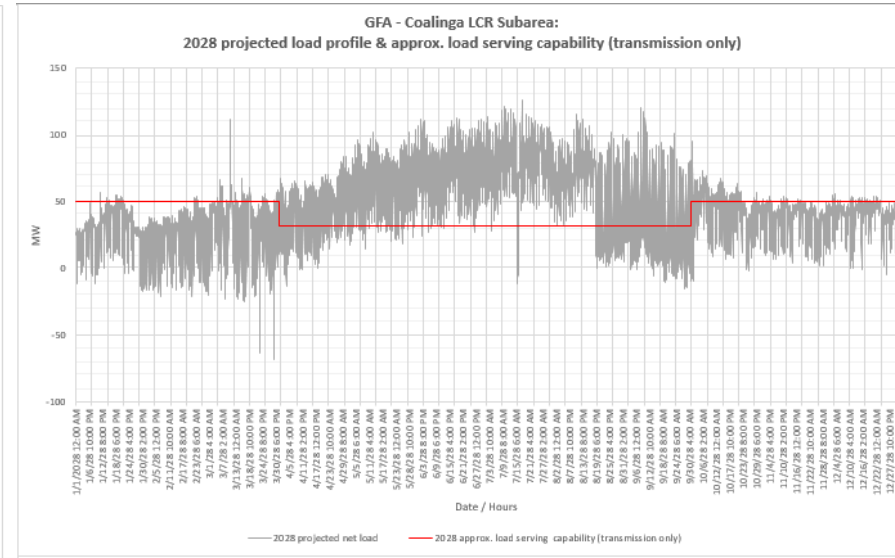
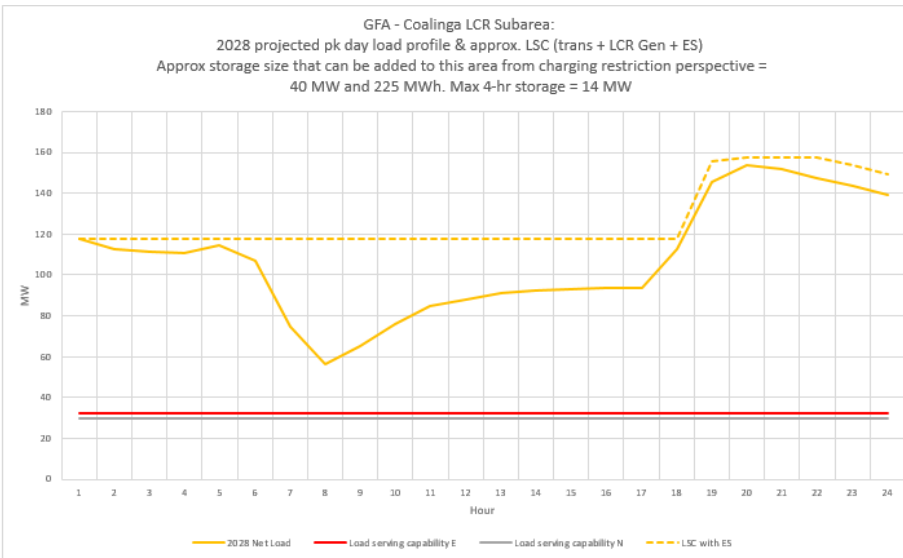
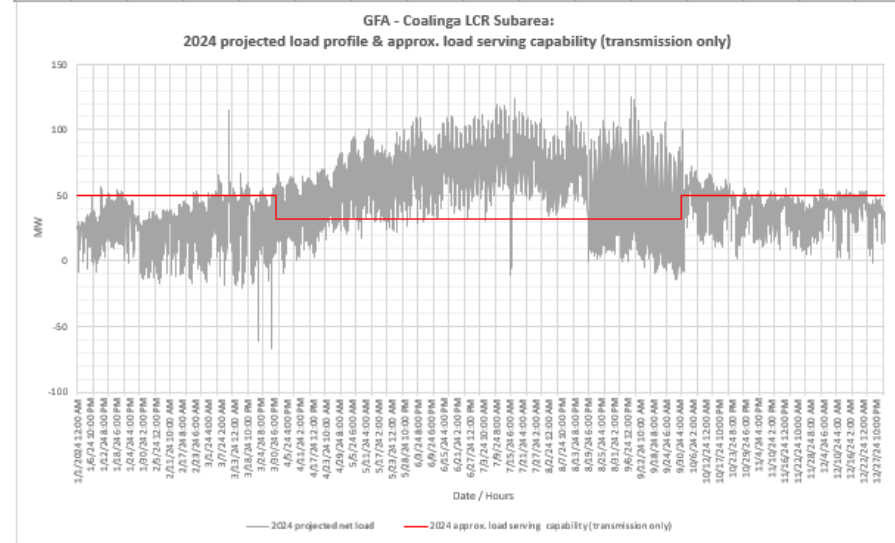
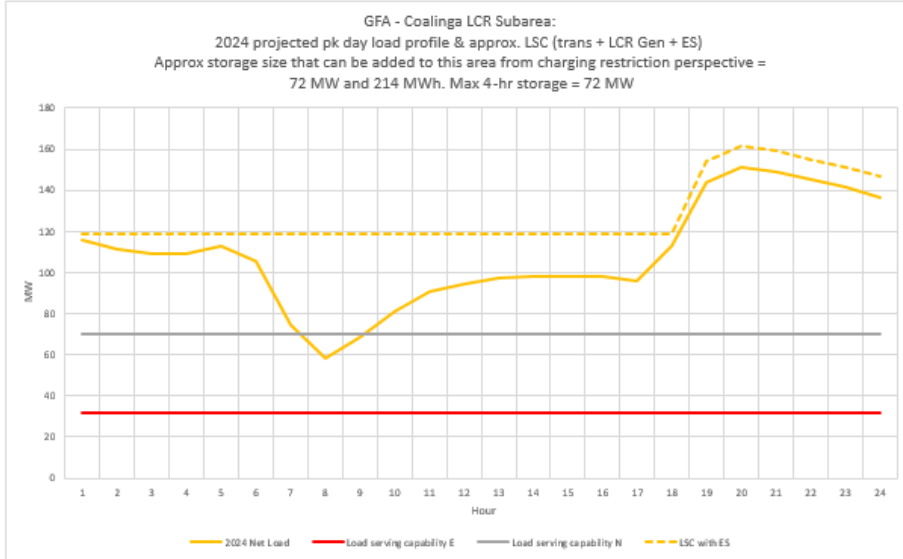

Borden Sub-area: Load and Resources

Load (MW)	2024	Generation (MW)	2024
Gross Load	142	Market/Net Seller	11
AAEE	-1	Battery	0
Behind the meter DG	-7	Muni/QF	0
Net Load	134	Solar	6
Transmission Losses	3	Existing 20-minute Demand Response	0
Pumps	0	Mothballed	0
Load + Losses + Pumps	137	Total Qualifying Capacity	17

Borden Sub-Area Requirements

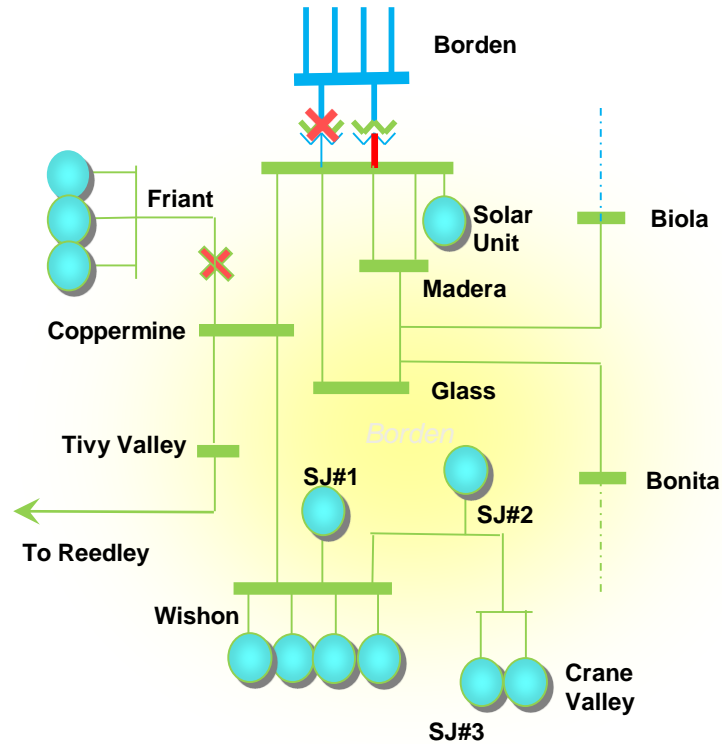

Limit	Category	Limiting Facility	Contingency	2024 LCR (MW)	2028 LCR (MW)
First Limit	P6	Borden 230/70 kV TB # 1	Friant - Coppermine 70 kV Line and Borden 230/70 kV TB # 4	9	Eliminated due to Project

Borden Sub-area: Load Profiles

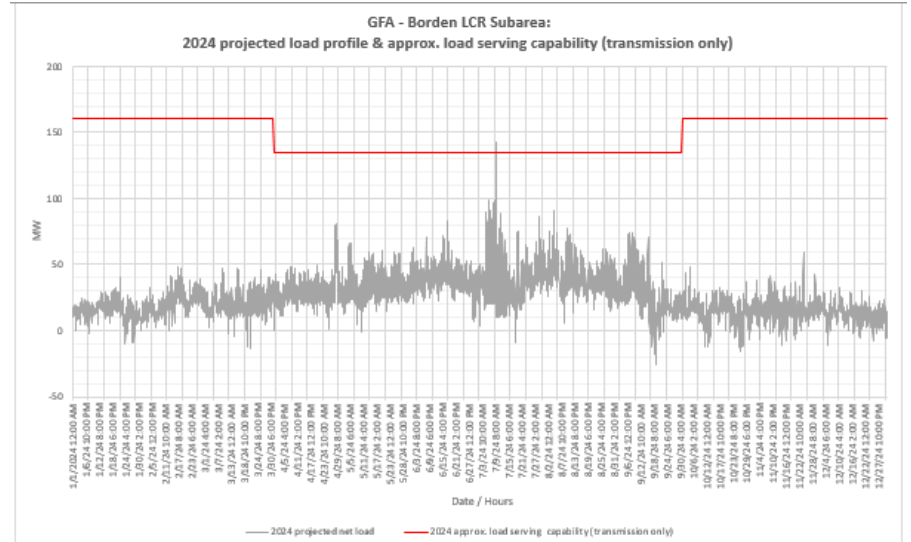
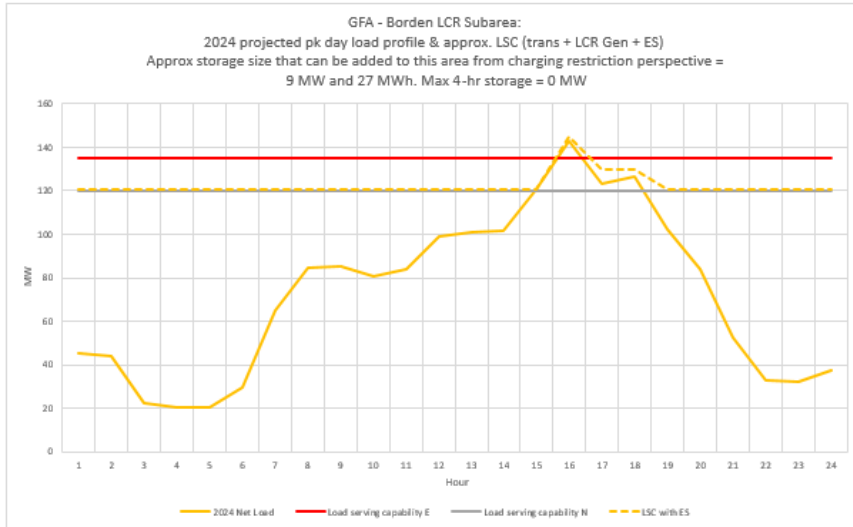

Reedley Sub-area: Load and Resources

Load (MW)	2024	2028	Generation (MW)	2024	2028
Gross Load	223	233	Market, Net Seller	39	39
AAEE	-2	-2	Battery	0	0
Behind the meter DG	-10	0	Muni/QF	0	0
Net Load	211	231	Solar	0	0
Transmission Losses	50	57	Existing 20-minute Demand Response	0	0
Pumps	0	0	Mothballed	0	0
Load + Losses + Pumps	261	288	Total Qualifying Capacity	39	39

Reedley Sub-Area Requirements

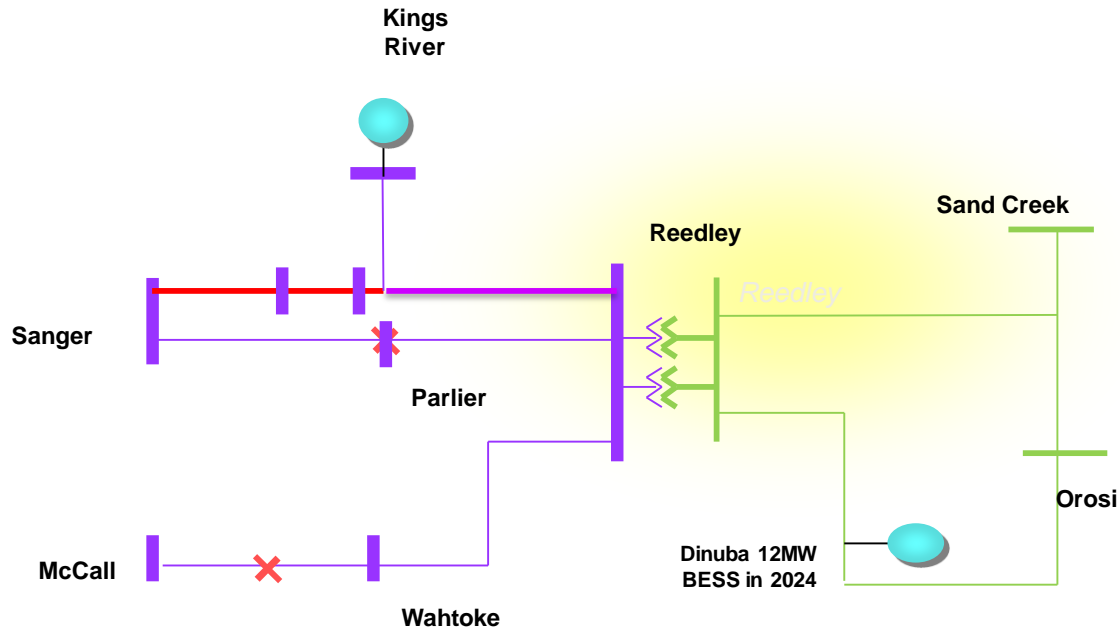

Limit	Category	Limiting Facility	Contingency	2024 LCR (MW)	2028 LCR (MW)
First Limit	P6	Kings River-Sanger-Reedley 115kV line with Wahtoke load online	McCall-Reedley 115kV Line & Sanger-Reedley 115kV line	132 (93)	148 (109)

Reedley Sub-area: Load Profiles

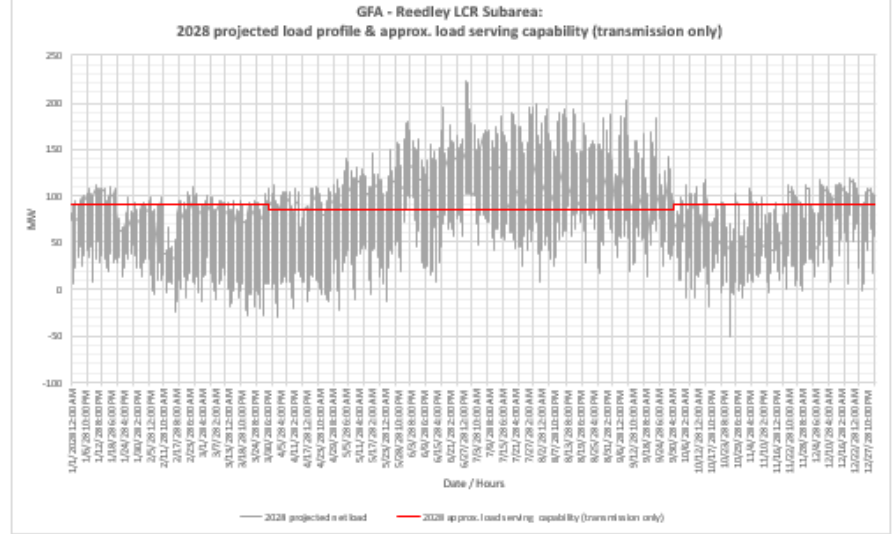
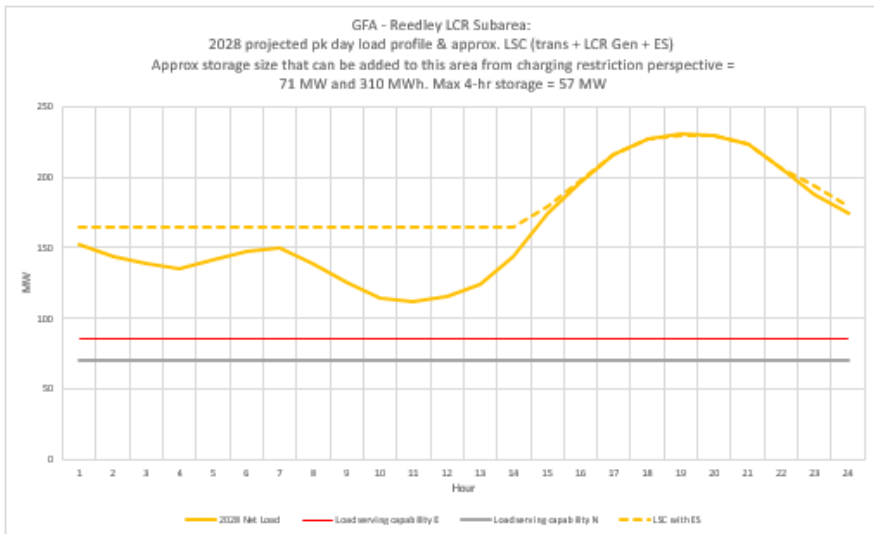
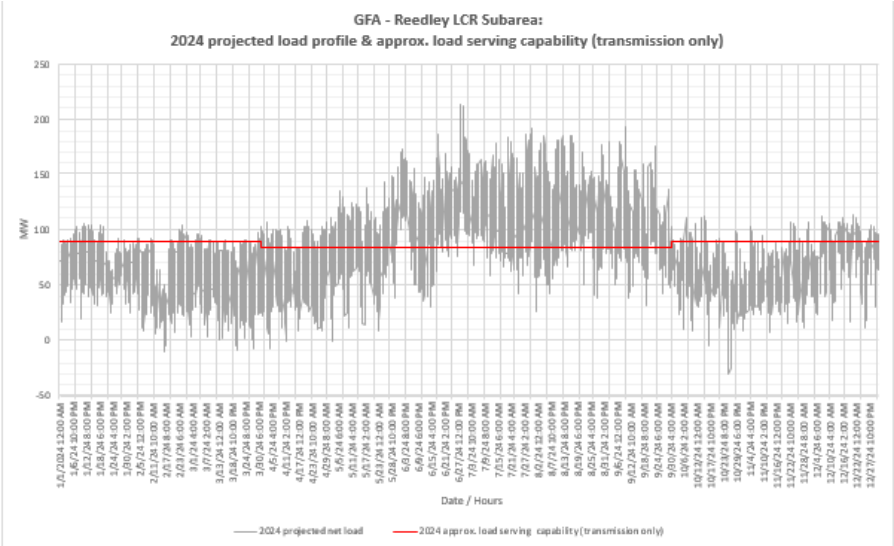
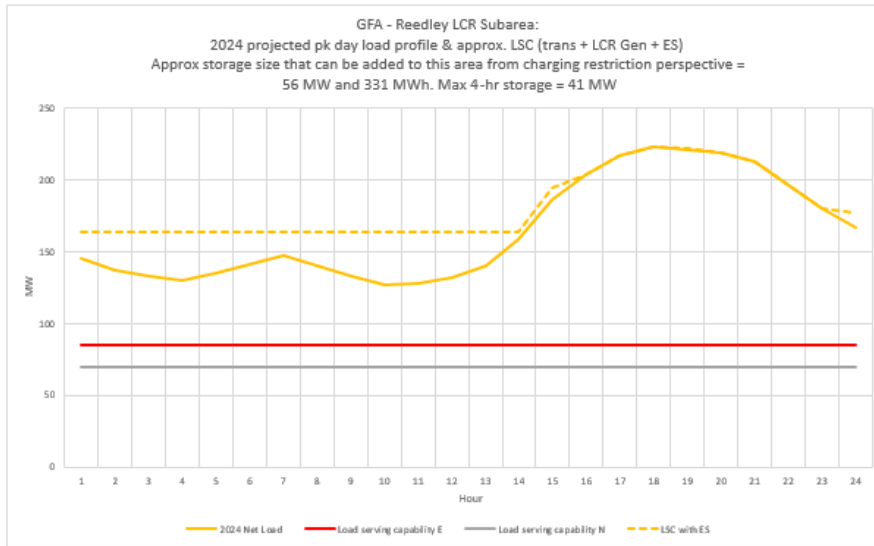

Panoche Sub-area: Load and Resources

Load (MW)	2024	2028	Generation (MW)	2024	2028
Gross Load	527	543	Market, Net Seller	284	284
AAEE	-3	-5	Battery	0	0
Behind the meter DG	-16	0	Muni/QF	104	104
Net Load	508	538	Solar	43	43
Transmission Losses	14	16	Existing 20-minute Demand Response	0	0
Pumps	0	0	Mothballed	0	0
Load + Losses + Pumps	522	554	Total Qualifying Capacity	431	431

Panoche Sub-Area Requirements

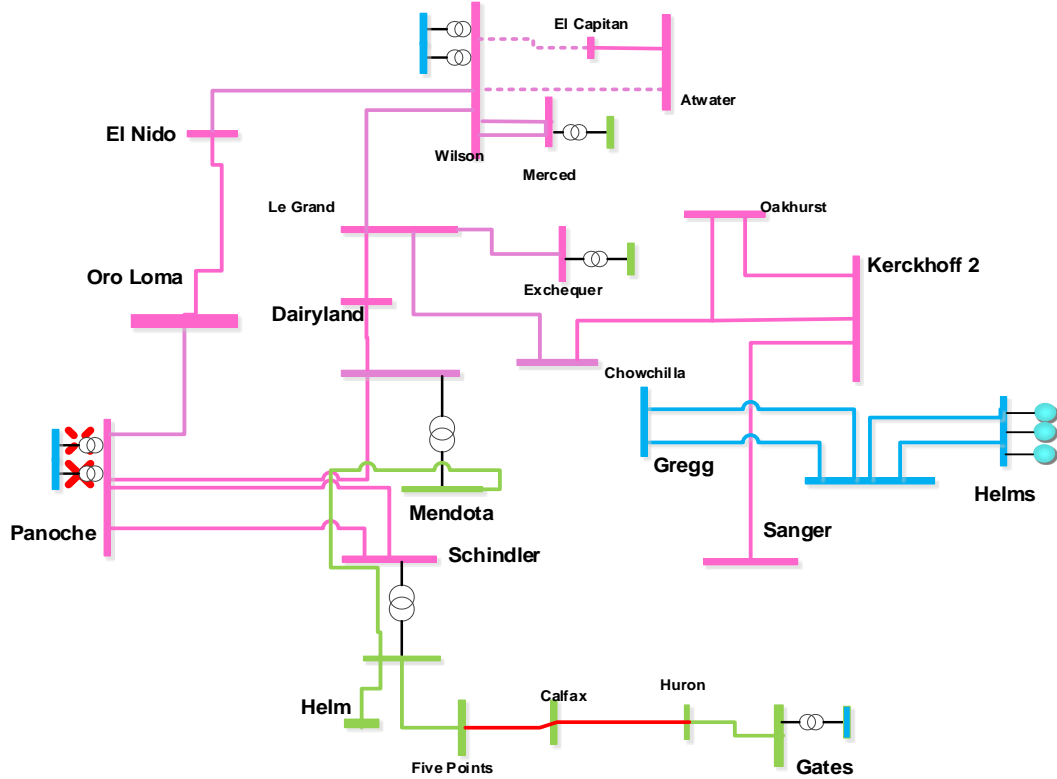

Limit	Category	Limiting Facility	Contingency	2024 LCR (MW)	2028 LCR (MW)
First Limit	P6	Five Points-Huron-Gates 70kV line	Panoche 230/115kV TB #2 and Panoche 230/115kV TB #1	412 (0 NQC) (24 Peak)	441 (10 NQC) (53 Peak)

Panoche Sub-area: Load Profiles

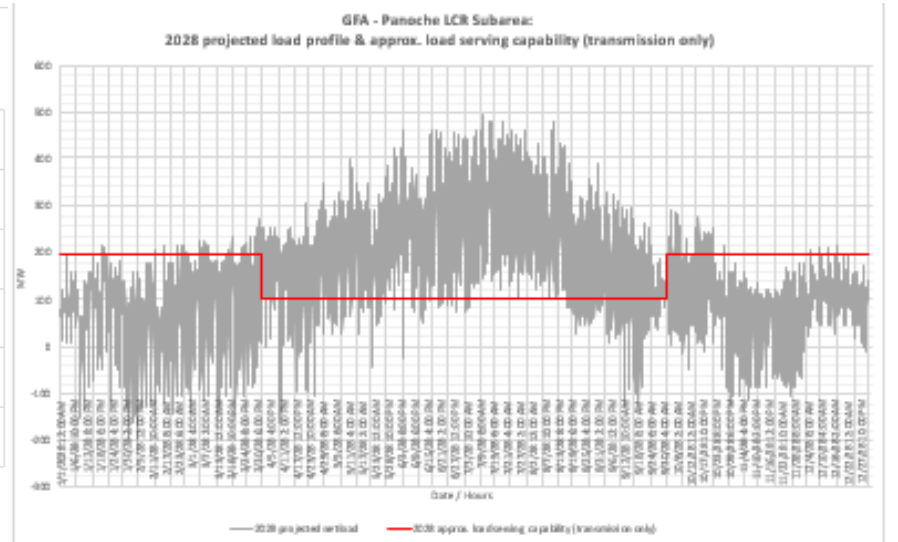
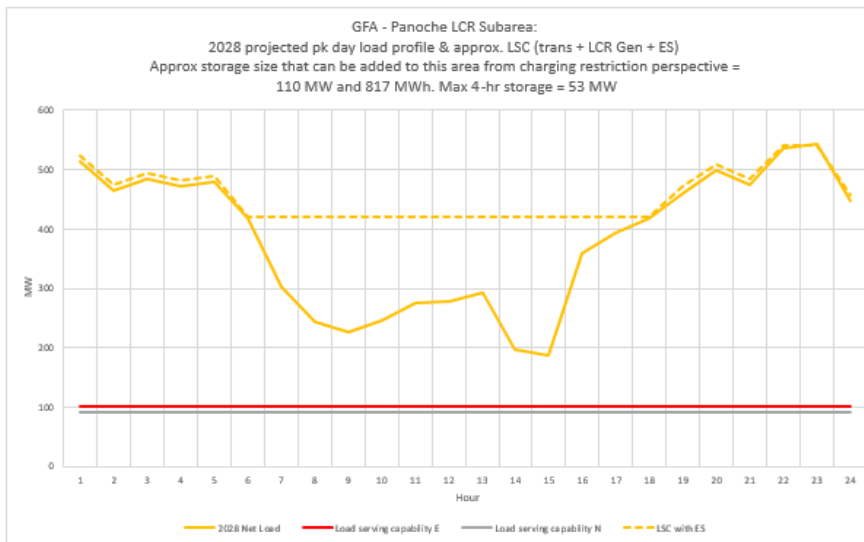
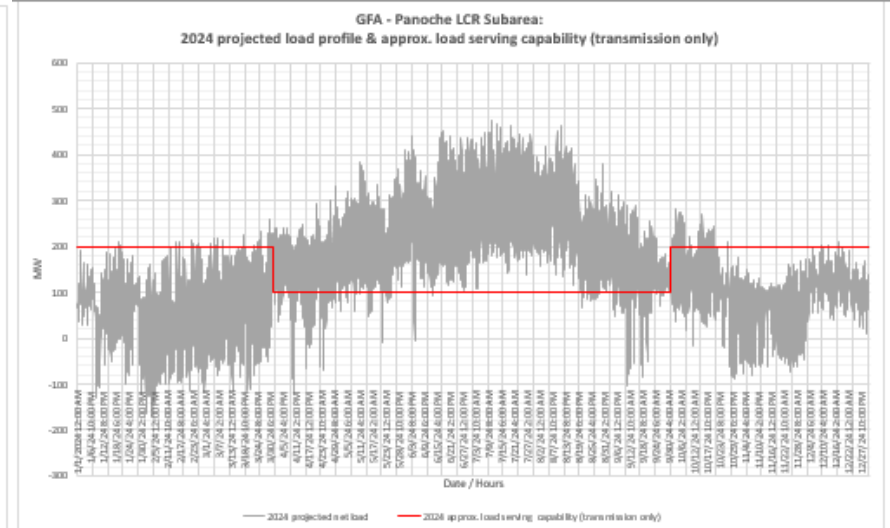
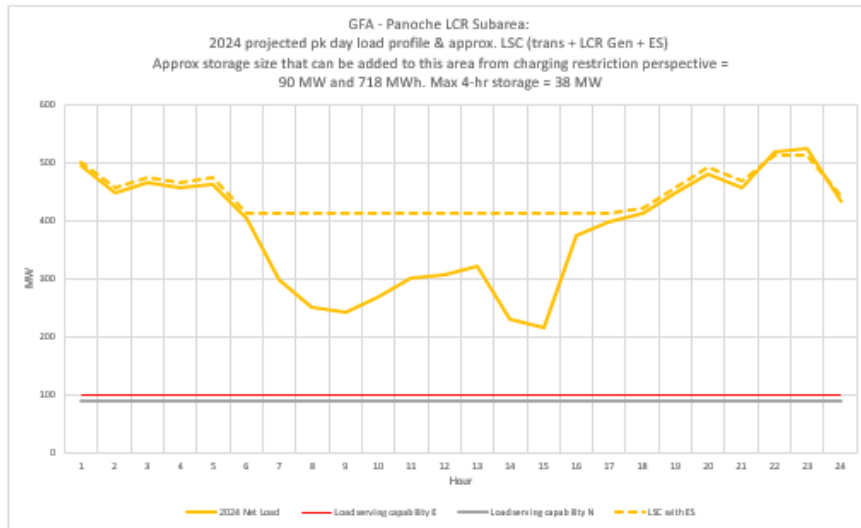

Wilson Sub-area: Load and Resources

Load (MW)	2024	2028	Generation (MW)	2024	2028
Gross Load	NA – Flow through area.		Market/Net Seller	146	146
AAEE			Battery	0	0
Behind the meter DG			Muni/QF	101	101
Net Load			Solar	27	27
Transmission Losses			Existing 20-minute Demand Response	0	0
Pumps			Mothballed	0	0
Load + Losses + Pumps			Total Qualifying Capacity	274	274

Wilson Sub-Area Requirements

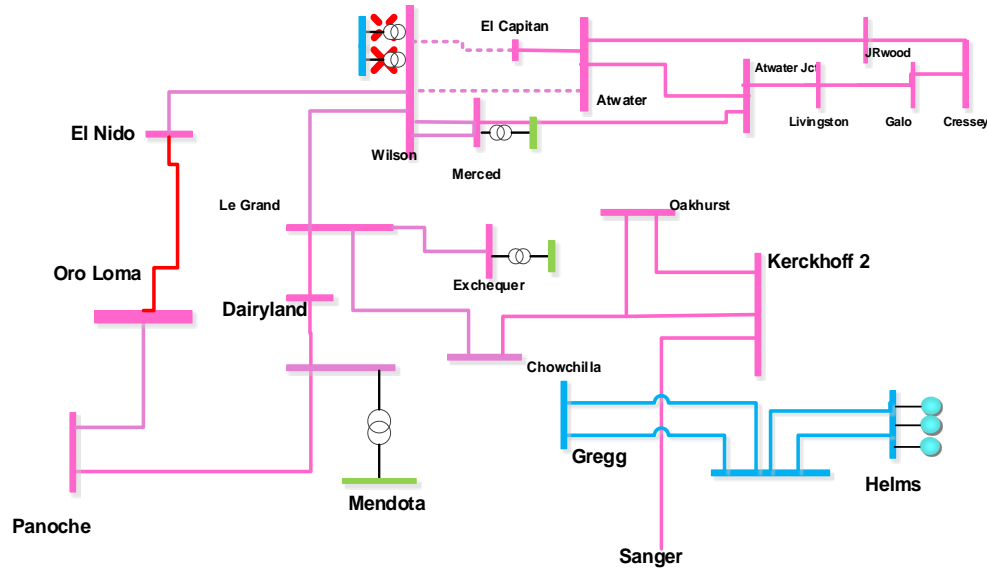

Limit	Category	Limiting Facility	Contingency	2024 LCR (MW)	2028 LCR (MW)
First Limit	P6	El Nido – Oro Loma 115 kV Line	Wilson 230/115kV TB #1 and Wilson 230/115kV TB #2	361 (87 NQC) (114 Peak)	Eliminated due to Project

Herndon Sub-area: Load and Resources

Load (MW)	2024	2028	Generation (MW)	2024	2028
Gross Load	1522	1603	Market/Net Seller	873	873
AAEE	-11	-13	Battery	0	0
Behind the meter DG	-62	0	Muni/QF	100	100
Net Load	1447	1589	Solar	29	29
Transmission Losses	29	31	Existing 20-minute Demand Response	0	0
Pumps	0	0	Mothballed	0	0
Load + Losses + Pumps	1476	1620	Total Qualifying Capacity	1002	1002

Herndon Sub-Area Requirements

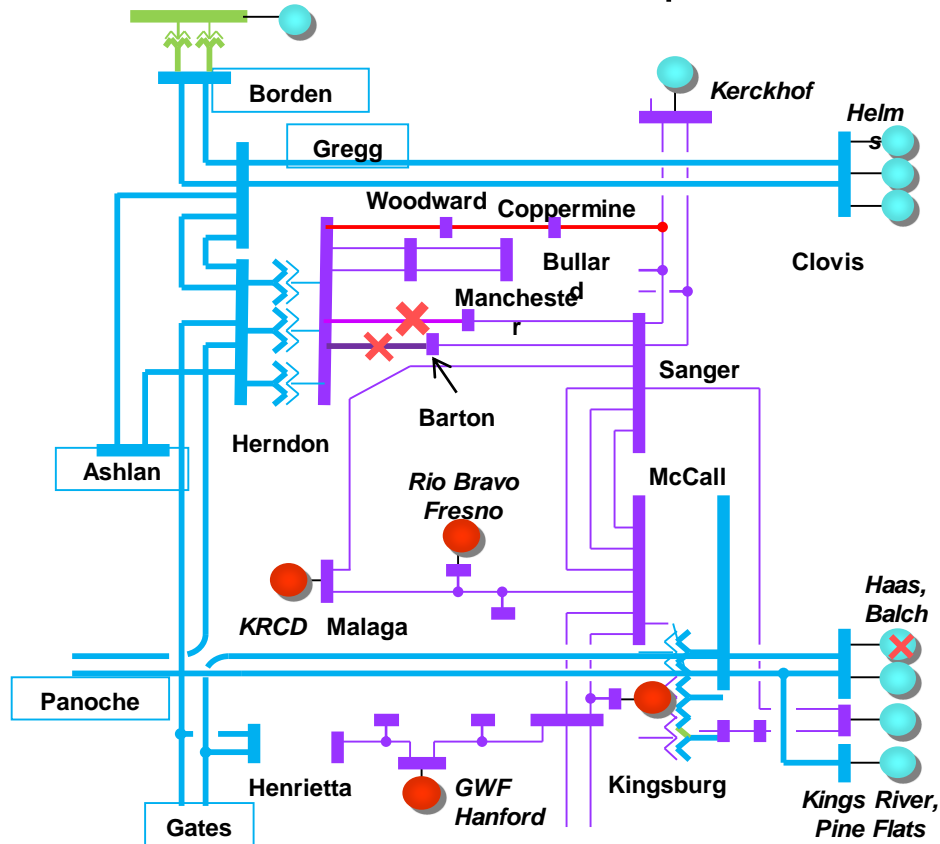

Limit	Category	Limiting Facility	Contingency	2024 LCR (MW)	2028 LCR (MW)
First limit	P6	Herndon 230/115kV Bank 3	Herndon 230/115 kV Bank 1 and Herndon 230/115 kV Bank 2	459	530

Herndon Sub-area: Load Profiles

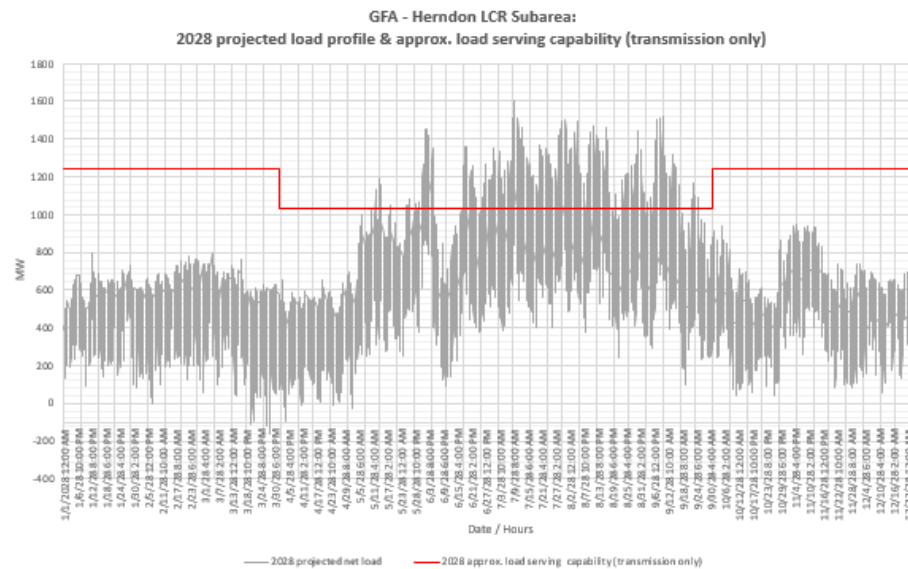
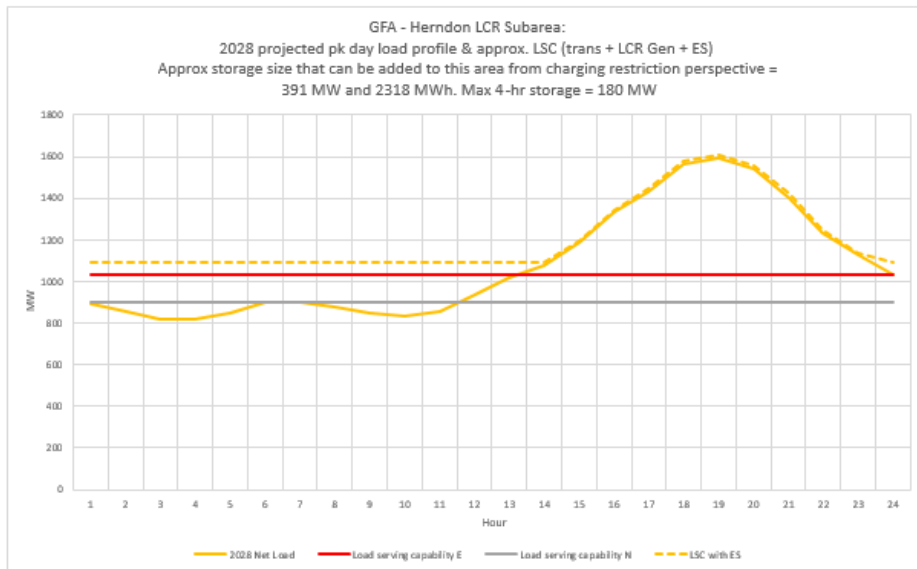
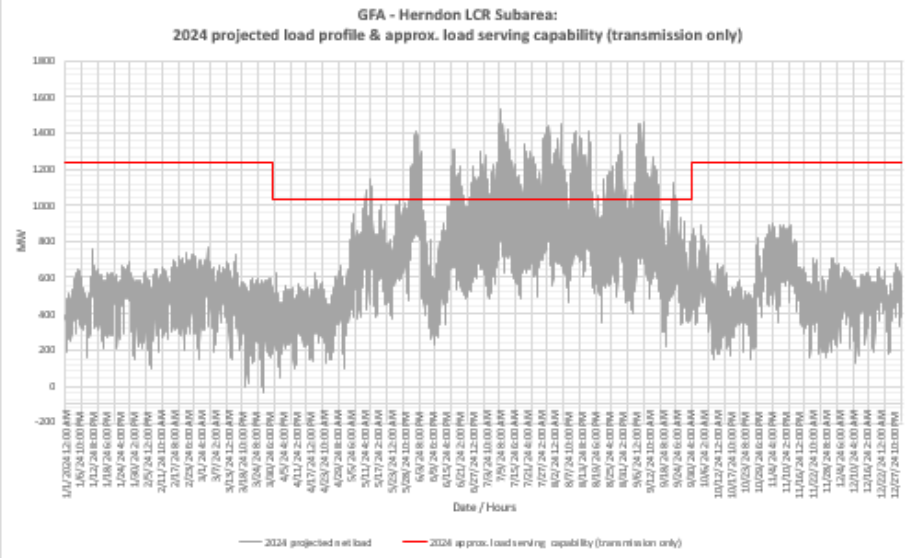
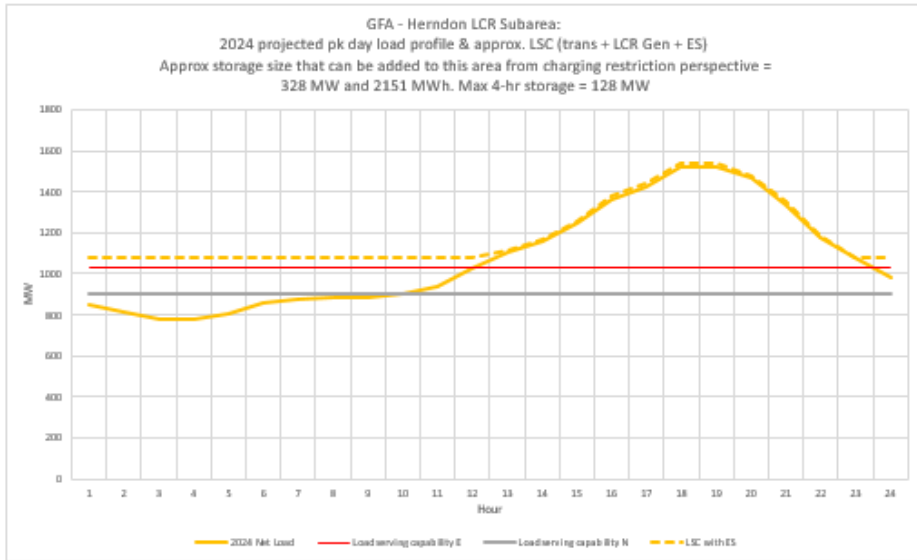

Overall Load and Resources

Load (MW)	2024	2028	Generation (MW)	2024	2028
Gross Load	3375	3524	Market/Net Seller	2382	2382
AAEE	-23	-30	Battery/Hybrid	358	358
Behind the meter DG	134	3	Muni/QF	206	206
Net Load	3217	3492	Solar	181	181
Transmission Losses	135	143	Existing 20-minute Demand Response	0	0
Pumps	0	0	Mothballed	0	0
Load + Losses + Pumps	3354	3637	Total Qualifying Capacity	3127	3127

Overall Sub-Area Requirements

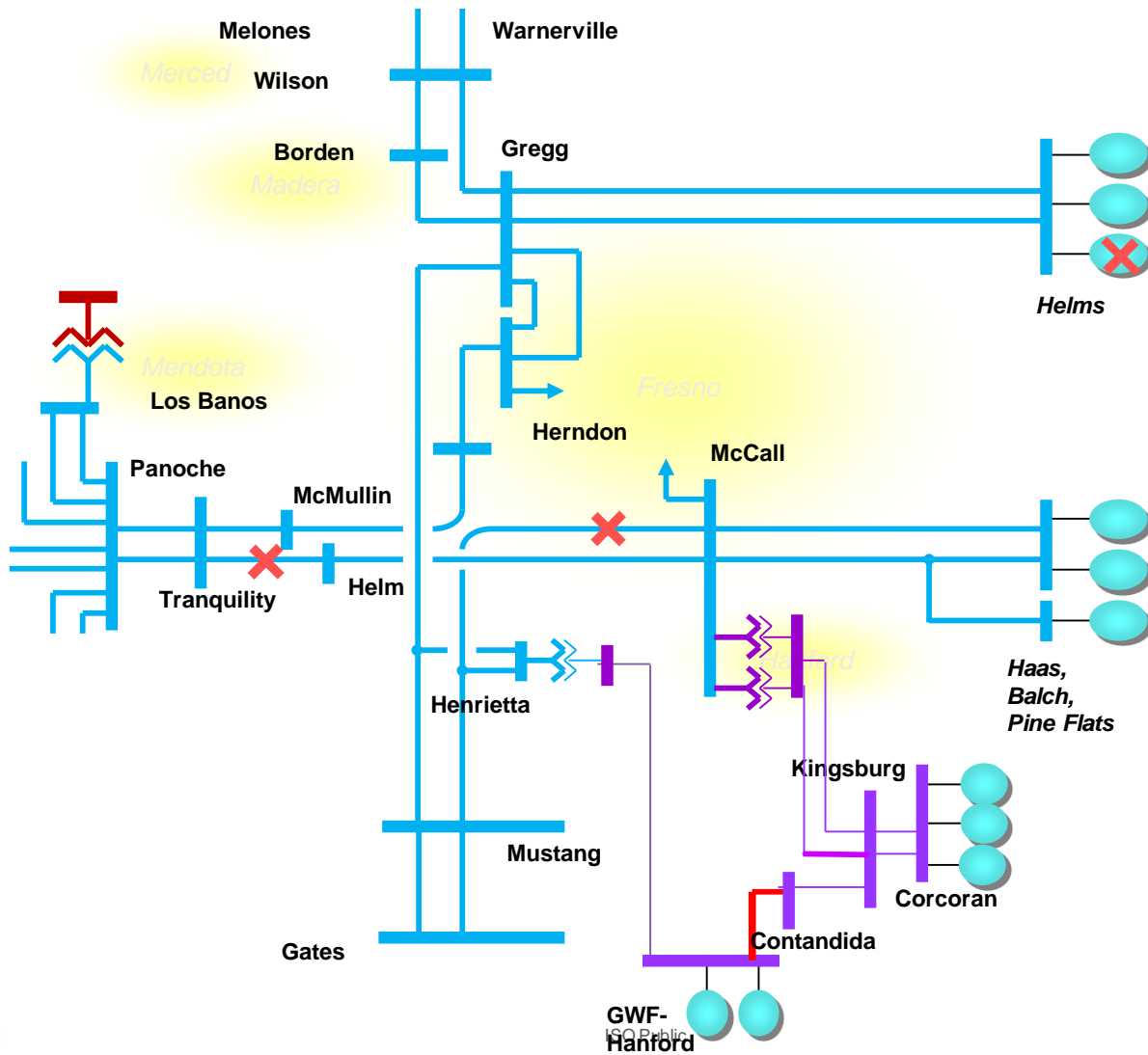

Overall Fresno Area: Requirements

Limit	Category	Limiting Facility	Contingency	2024 LCR (MW)	2028 LCR (MW)
First limit	P6	Huron Jct- Calflax 70kV line (2024) Henrietta 230/115kV Bank 3 (2028)	Gates-Panoche #1 230kV Line and Gates-Panoche #2 230kV line (2024) Helm-Mccall 230kV Line and CHSR09 sw sta- Mustang 230kV Line (2028)	2077	2728

Study Year	Generation Capacity Needed (MW)	NQC Deficiency (MW)	Total MW Need
2024	2077	275	2352
2028	2728	210	2938

Overall Sub-area: Load Profiles

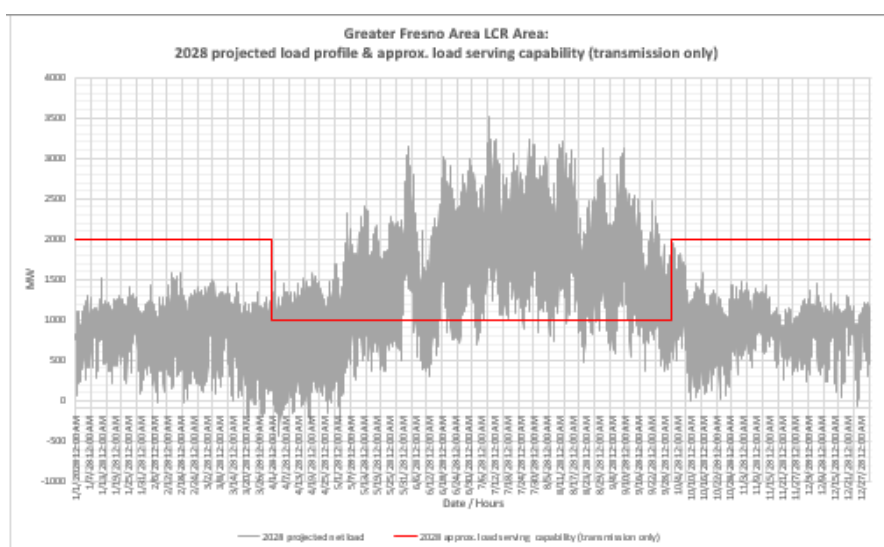
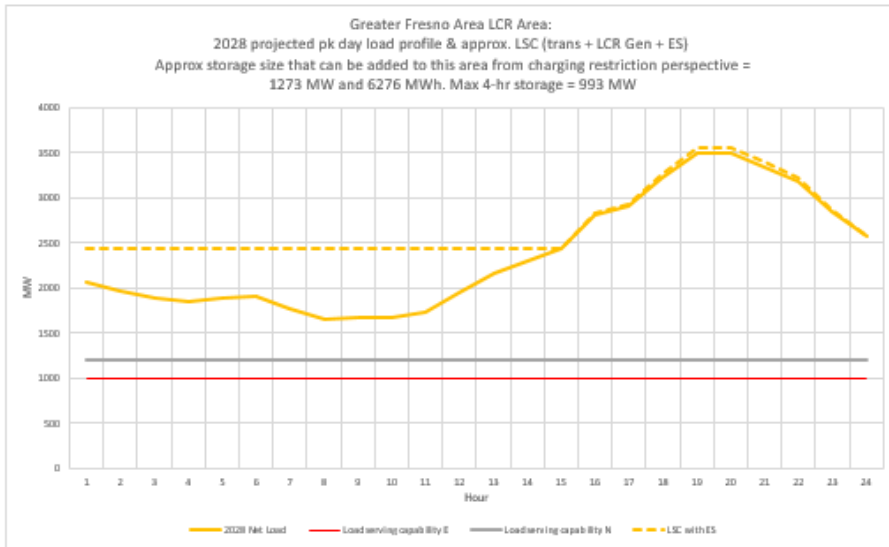
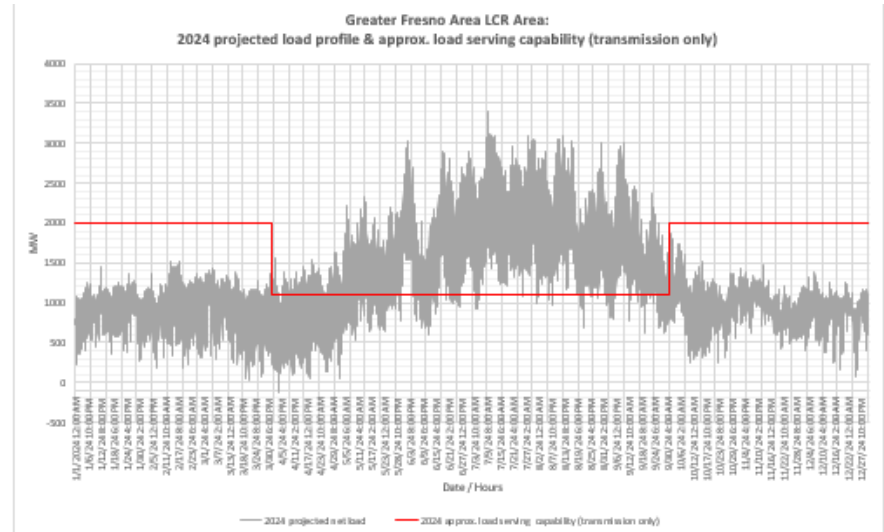
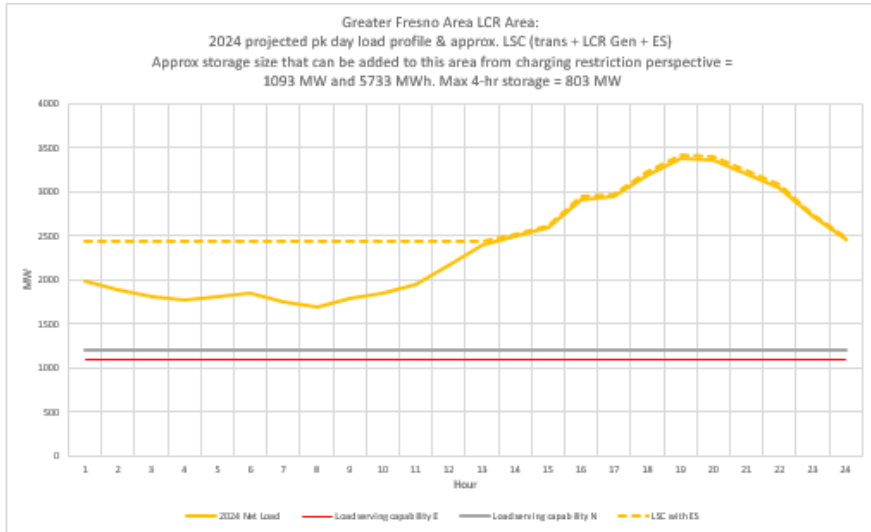

Changes Compared to Previous LCR Requirements

Sub-area	2023		2024		2027		2028	
	Load	LCR	Load	LCR	Load	LCR	Load	LCR
Hanford	199	50	208	58	206	58	224	62
Coalinga	110	73 (70 Peak; 45 NQC)	150	110 (107 Peak; 95 NQC)	115	77 (74 Peak, 49 NQC)	156	116 (113 Peak, 101 NQC)
Borden	143	9	137	9	Eliminated due to Project		Eliminated due to Project	
Reedley	217	118 (81)	261	132 (93)	248	134 (97)	288	148 (109)
Panoche 115 kV	463	295	522	412 (24 Peak; 0 NQC)	479	383	554	441 (53 peak; 10 NQC)
Wilson 115/70 kV	Flow-Through	422* (107 NQC) (165 Peak)	Flow-Through	361* (114 Peak) (87 NQC)	Flow-Through	500 (186 NQC) (244 Peak)	Eliminated due to Project	
Herndon	1494	327	1476	459	1557	363	1620	530
Overall	3288	1870	3354	2077	3292	2179	3637	2728

The overall Fresno requirements have increased mostly due to load forecast increase.